

99199

Dimensions

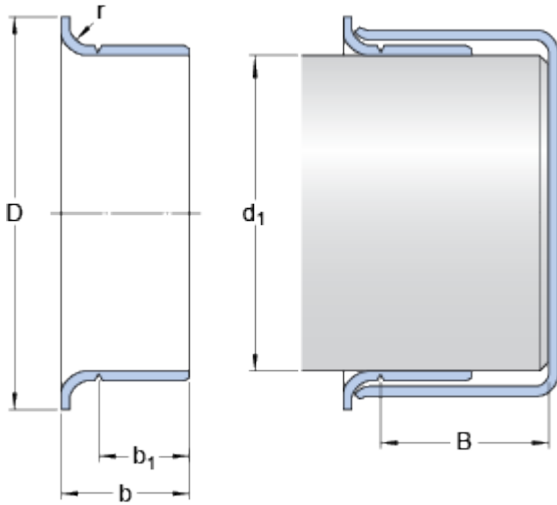

Nominal dimensions

d_1		50.8	mm
D		61.112	mm
Tolerance outside diameter D	\pm	1.6	mm
b		17.475	mm
Tolerance width b	\pm	0.8	mm
b_1		14.3	mm
Tolerance width b_1	\pm	0.8	mm
B	max.	25.4	mm
r	max.	3.18	mm

Shaft diameter range

d_1	min.	50.724	mm
d_1	max.	50.876	mm